

1

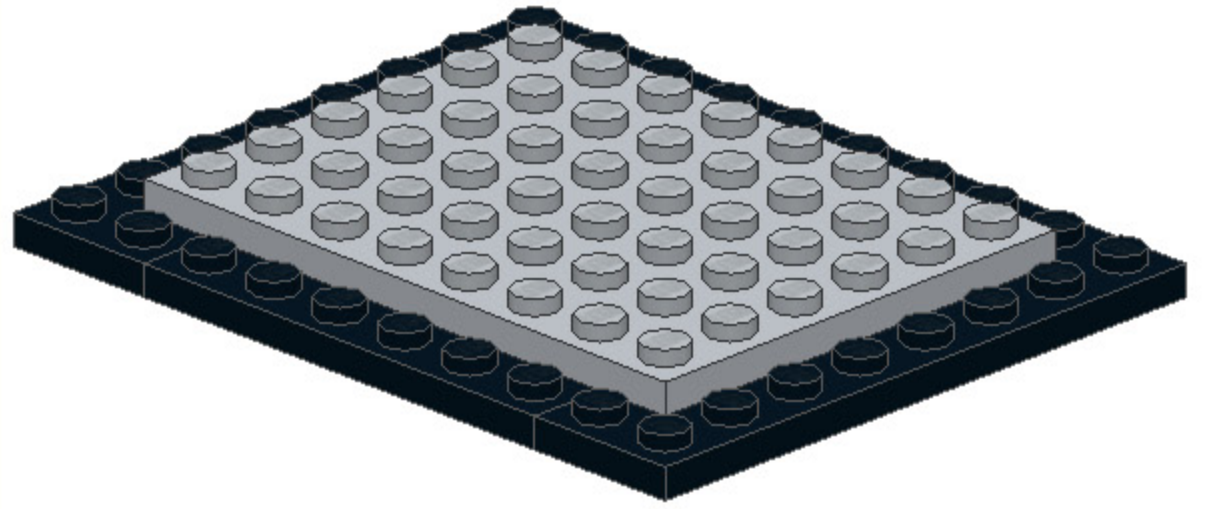

2

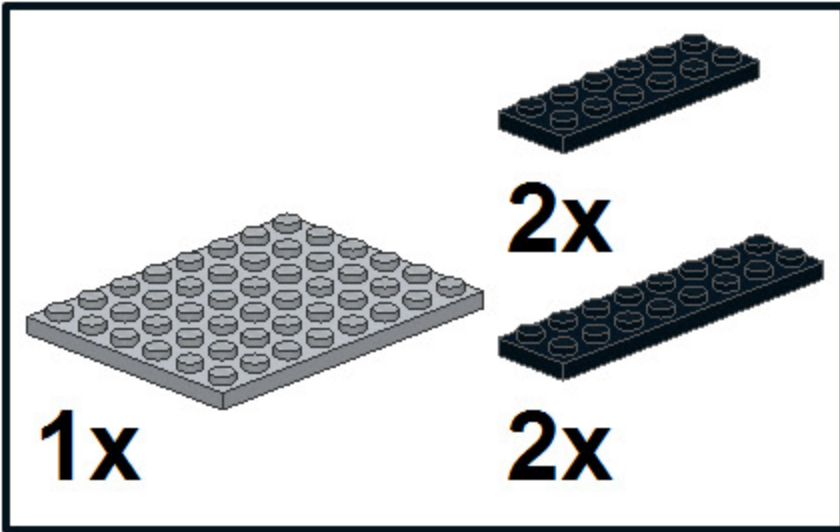
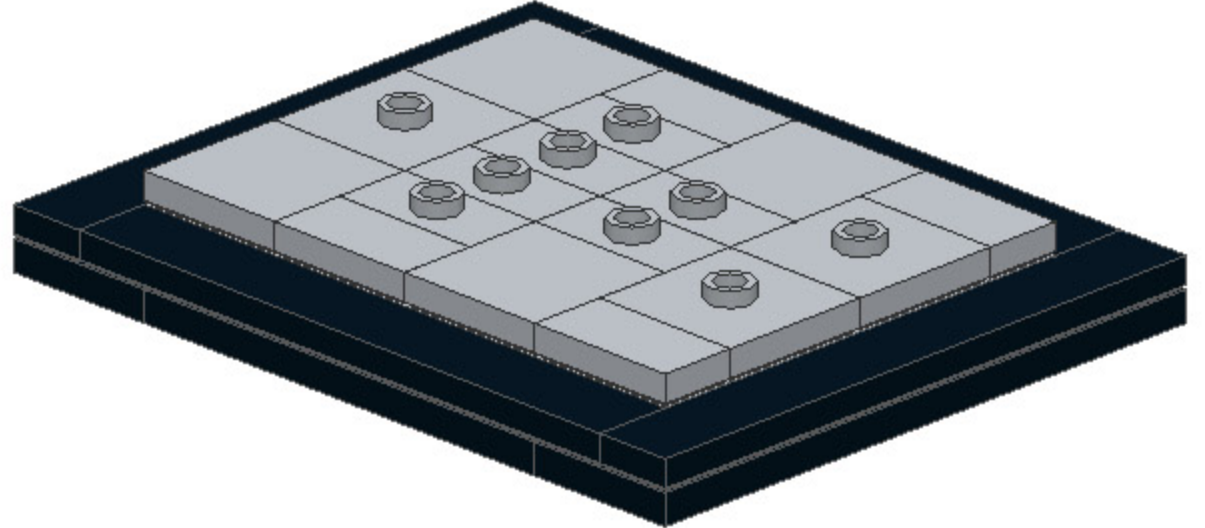
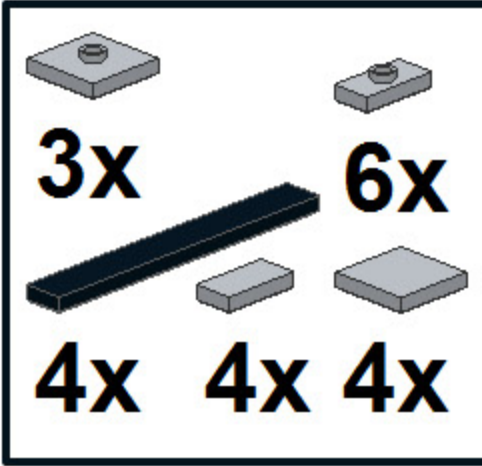

3

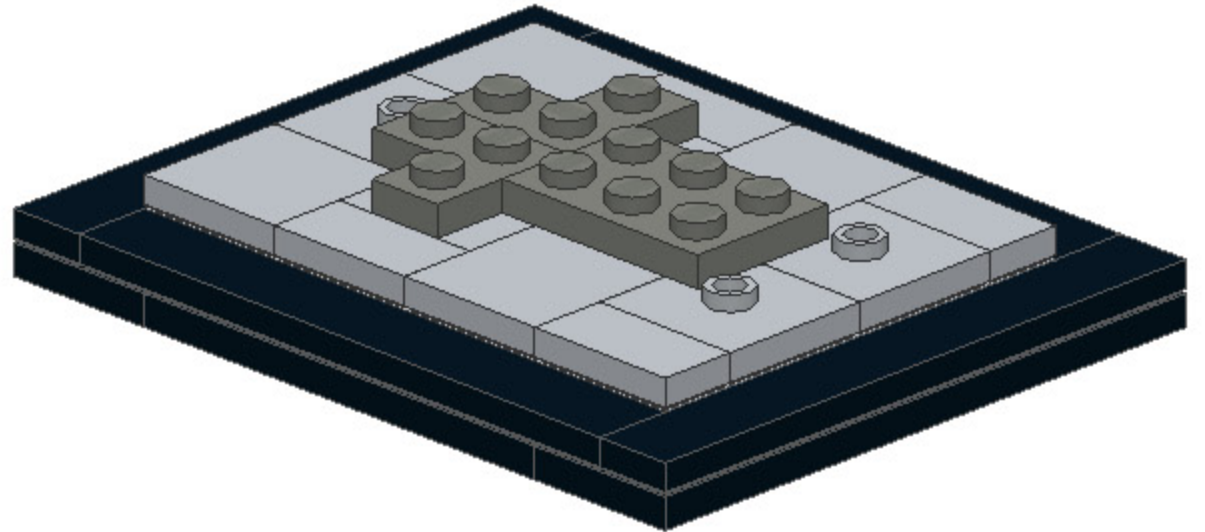
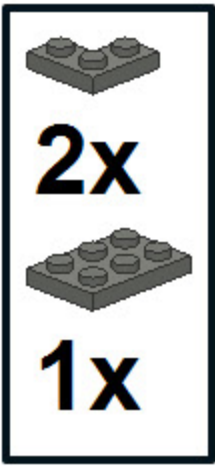

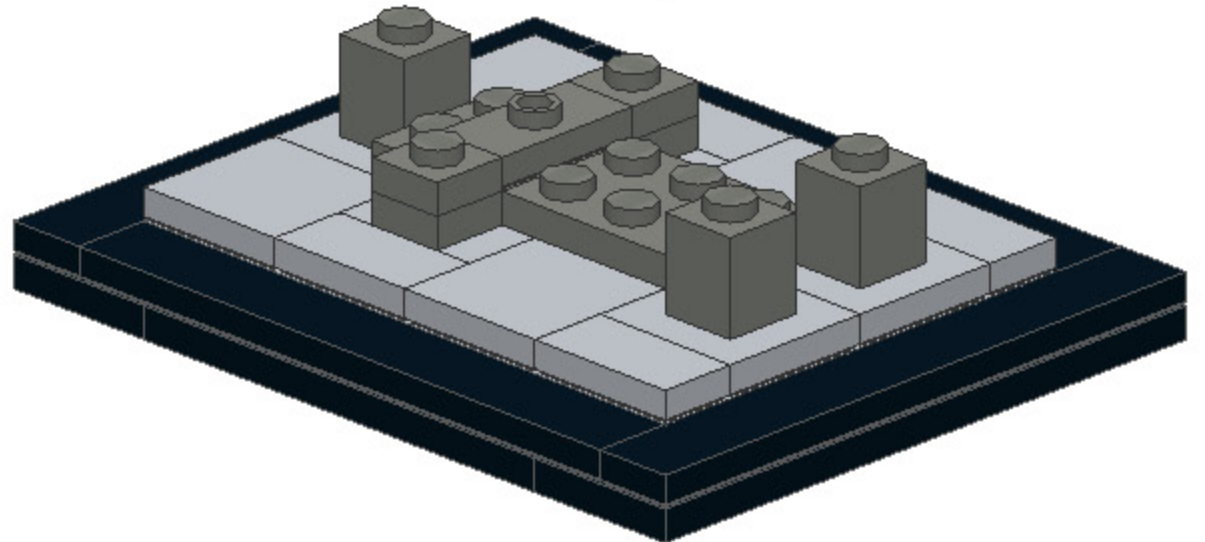
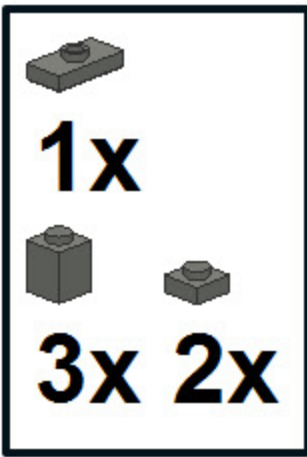

4



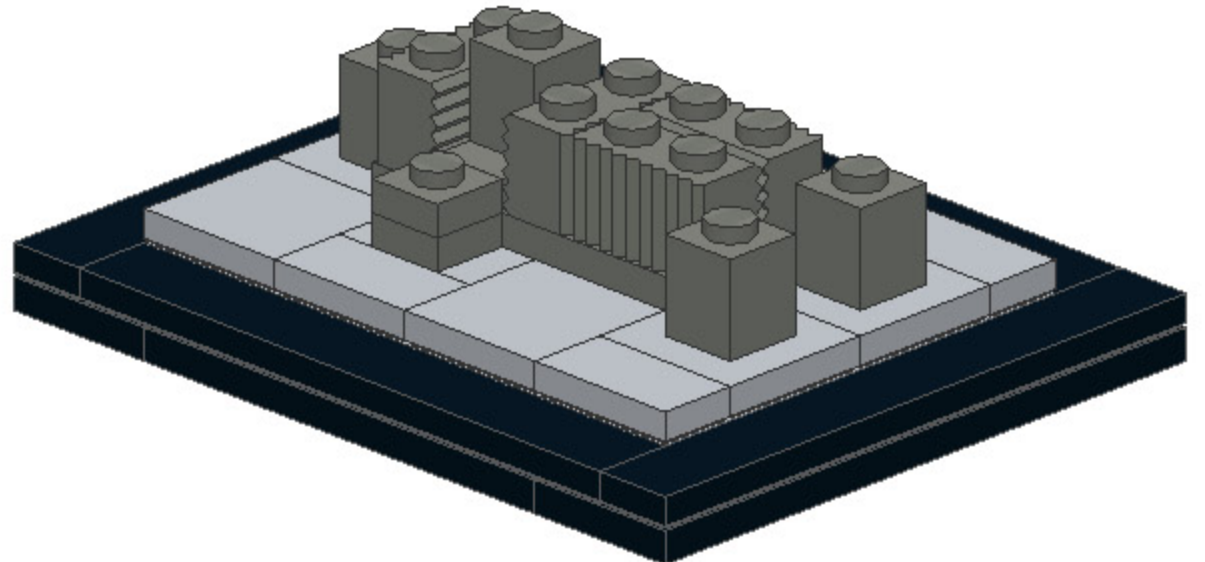

5



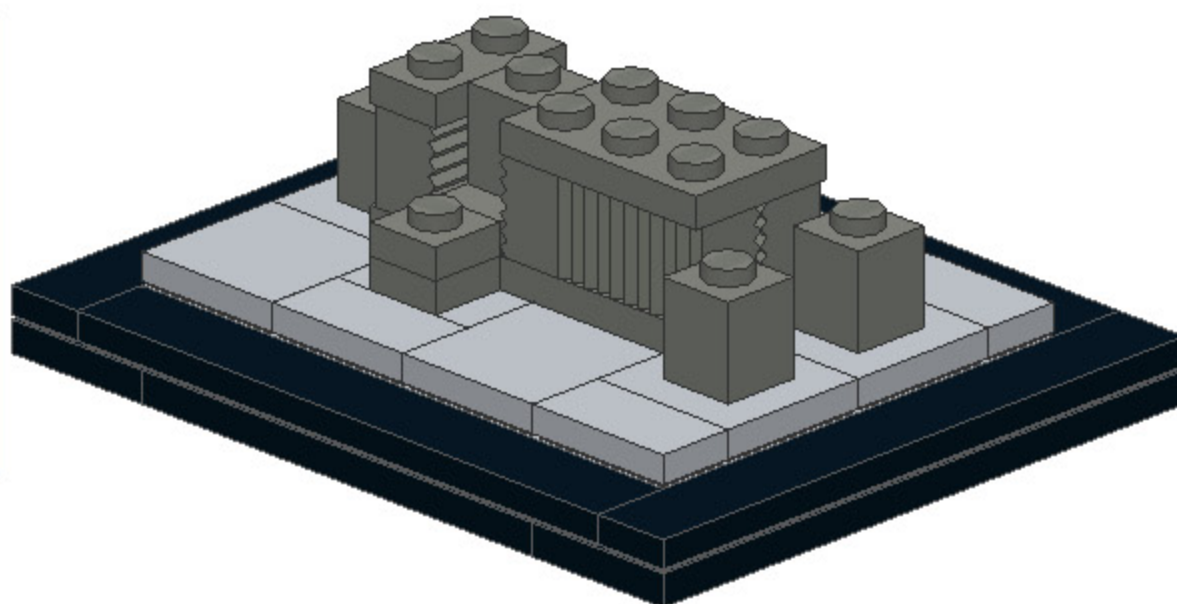

- 6**
-  **1x**
 -  **1x**



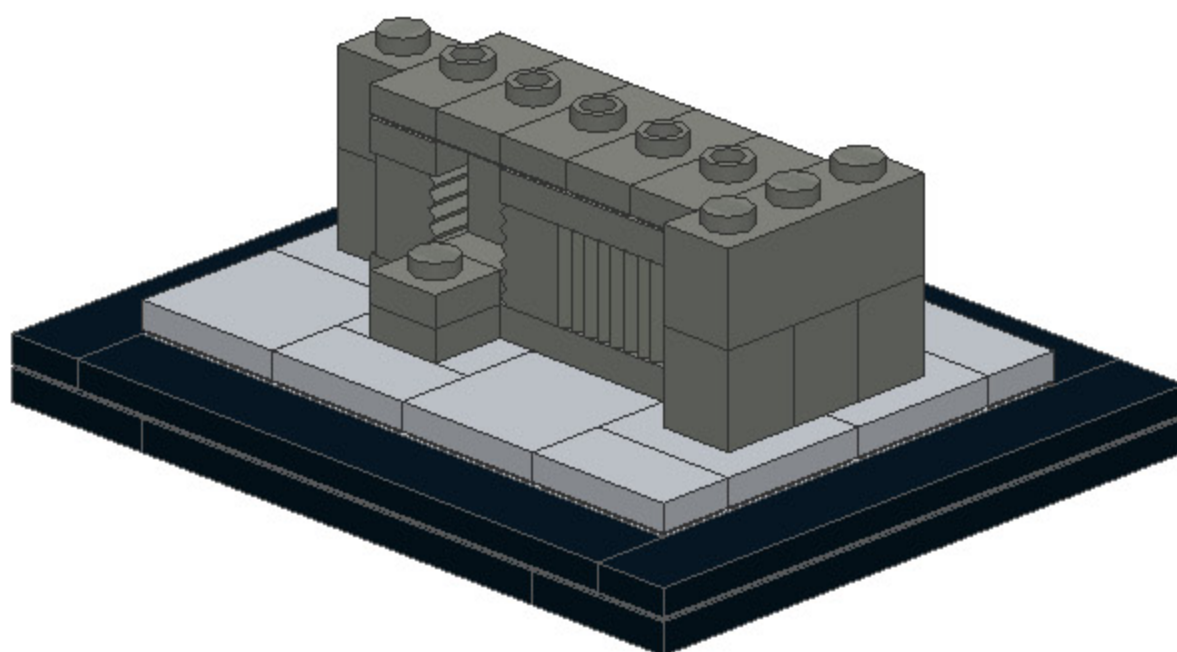

- 7**
-  **5x**
 -  **2x**
 -  **1x**



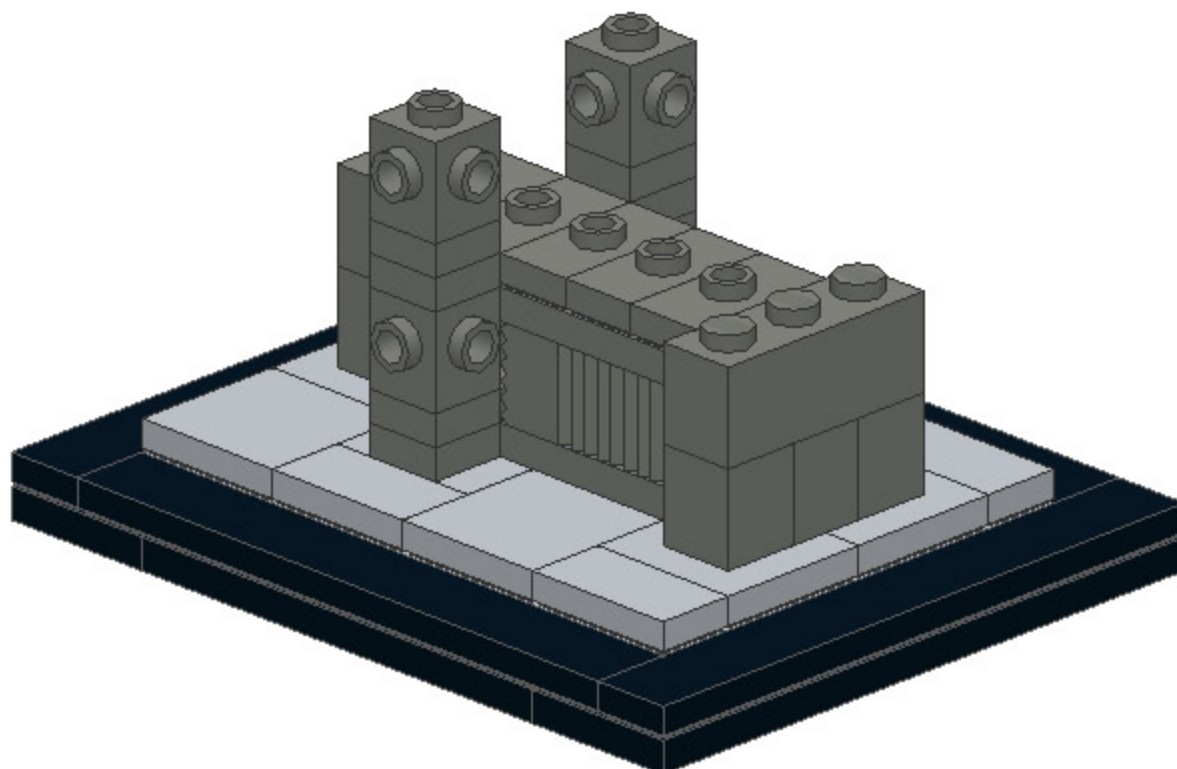

- 8**
-  **4x**
 -  **4x**

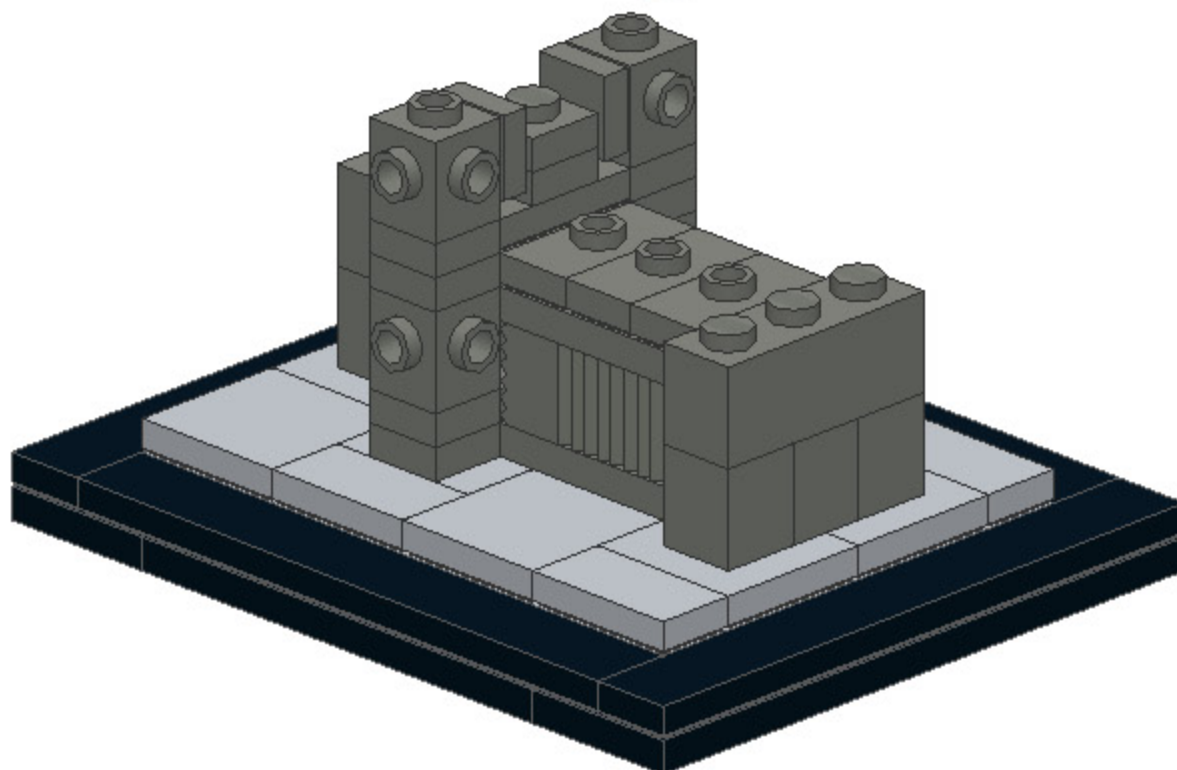

- 9**
-  **2x**
 -  **2x**
 -  **1x**



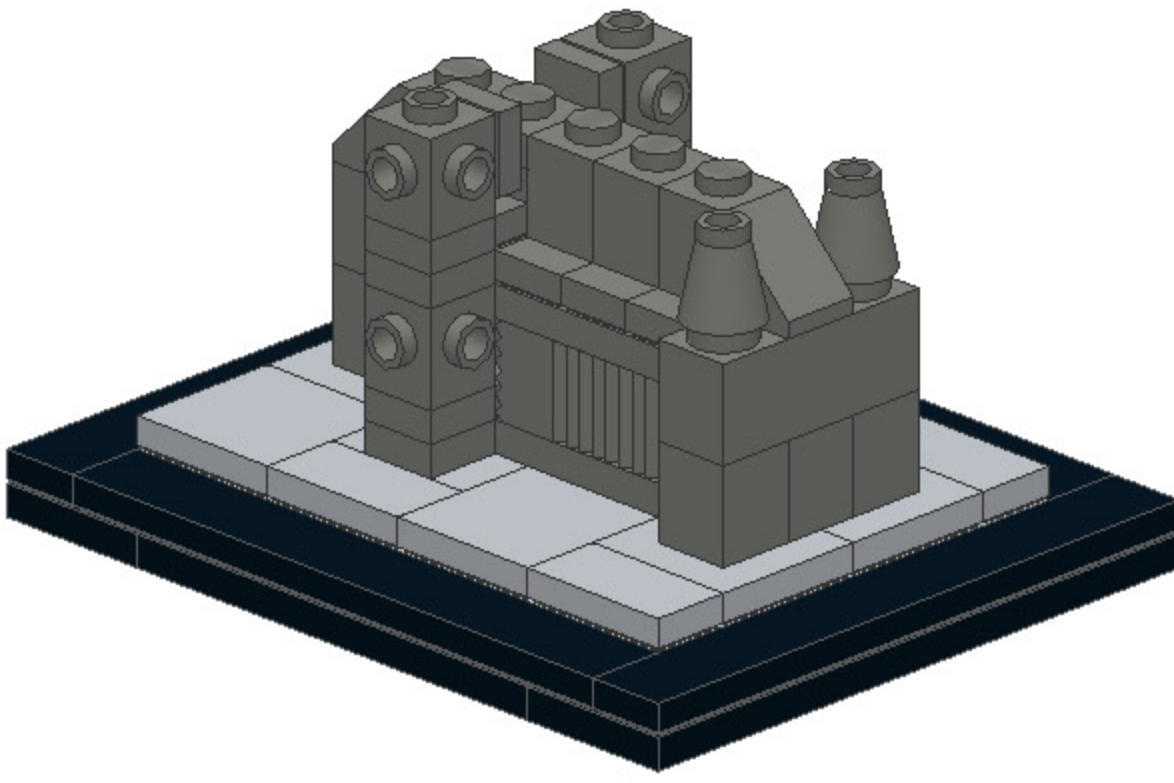

10

-  2x
-  2x
-  2x



11

-  1x
-  1x

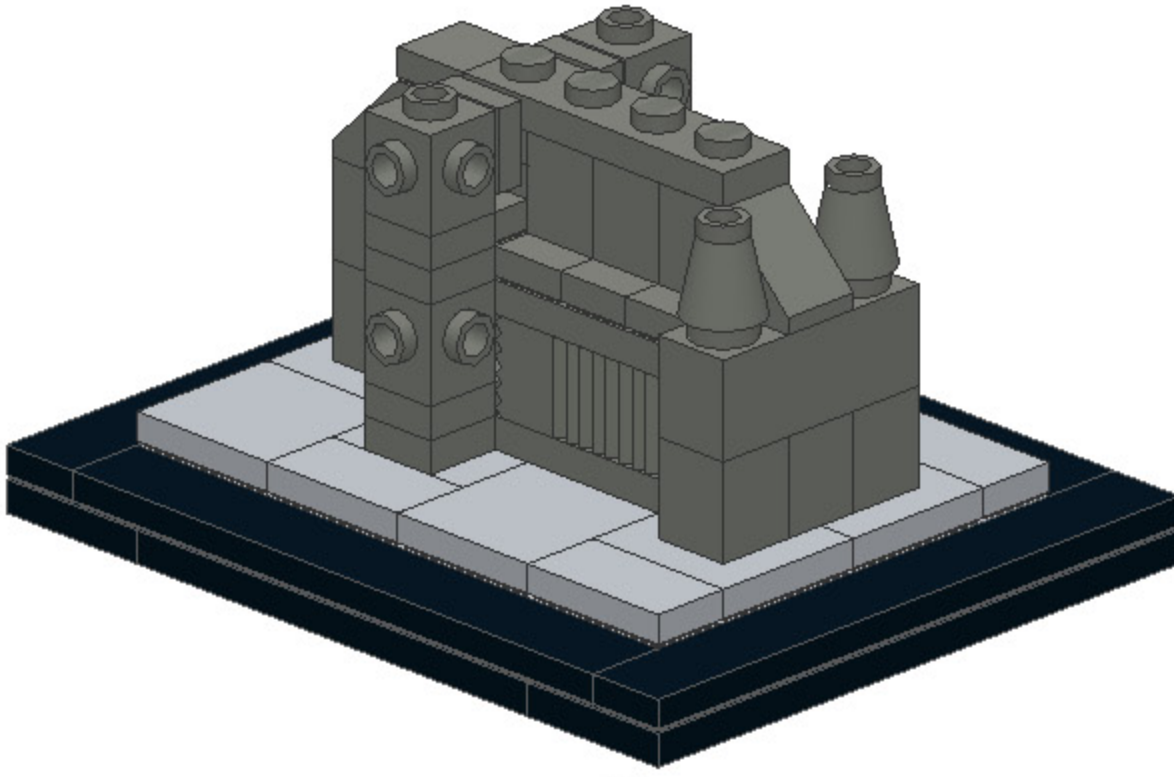

12

-  3x

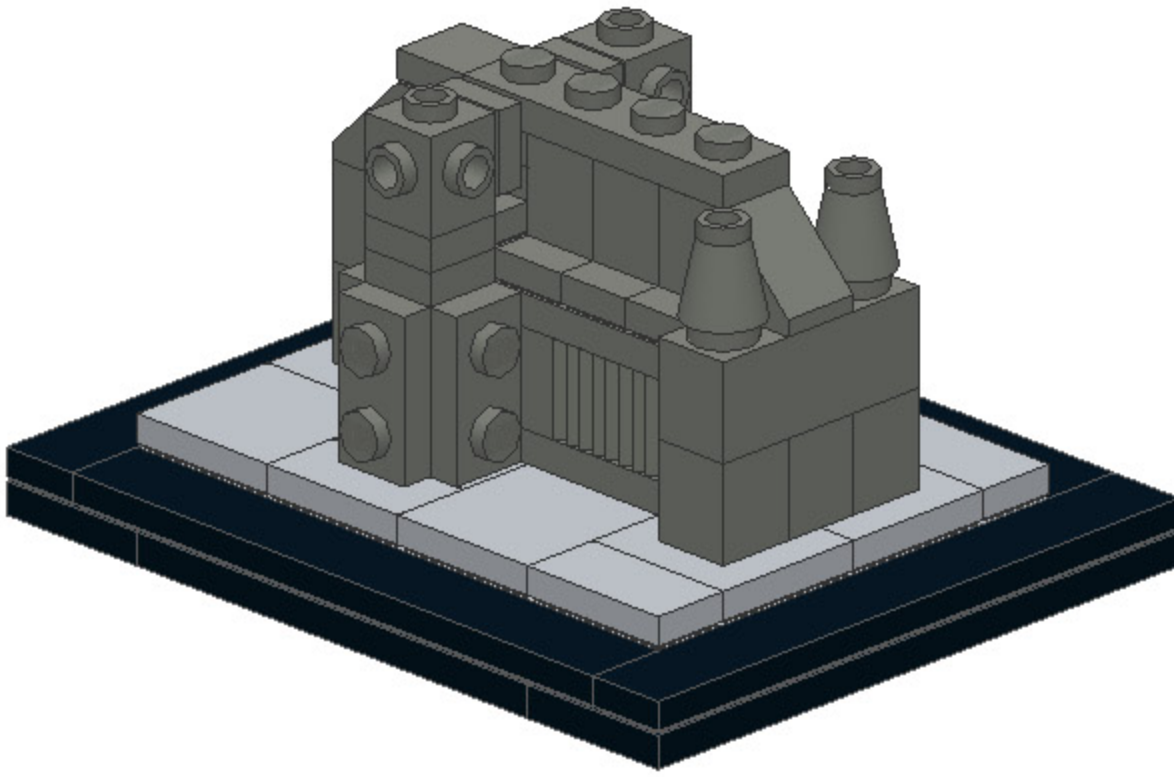

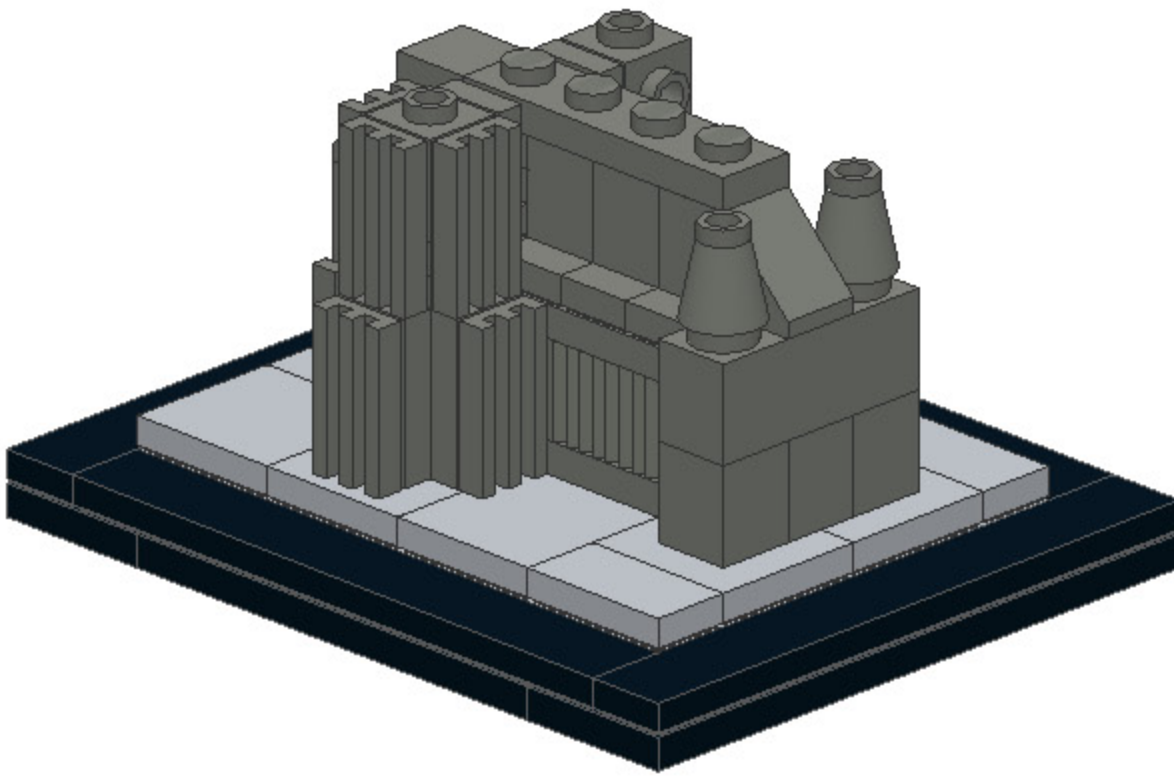

13

-  6x



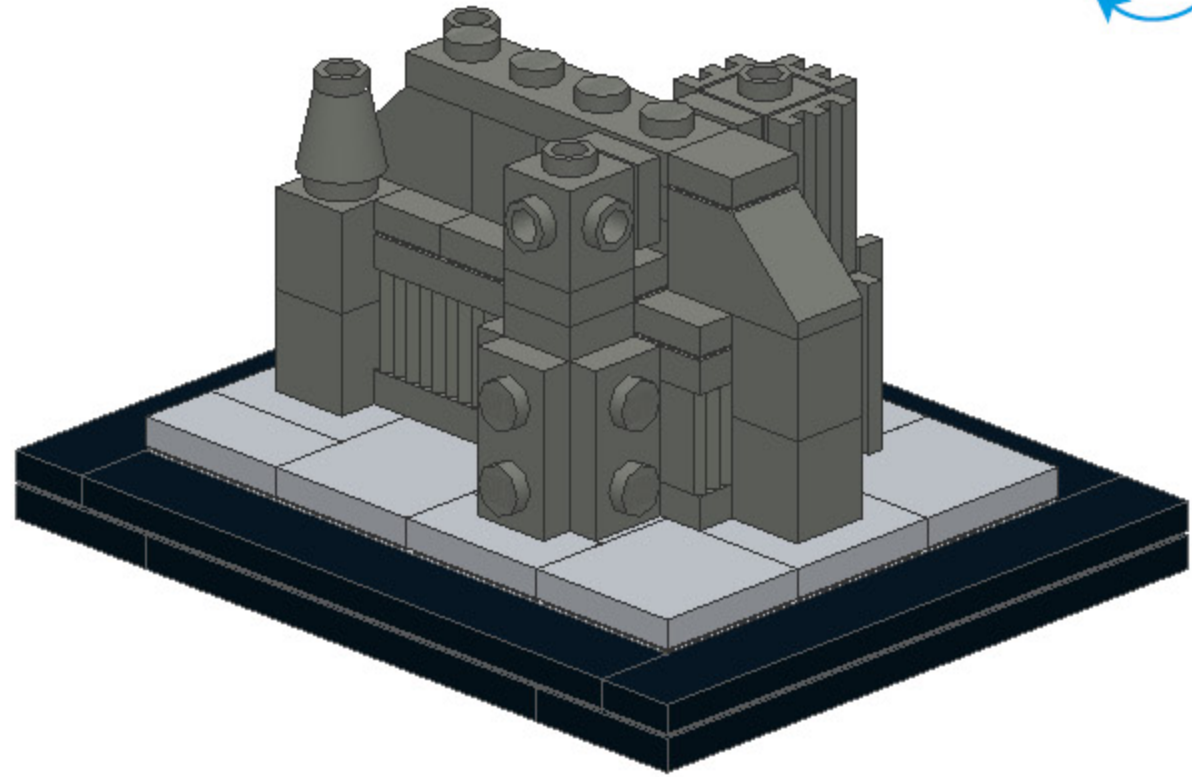



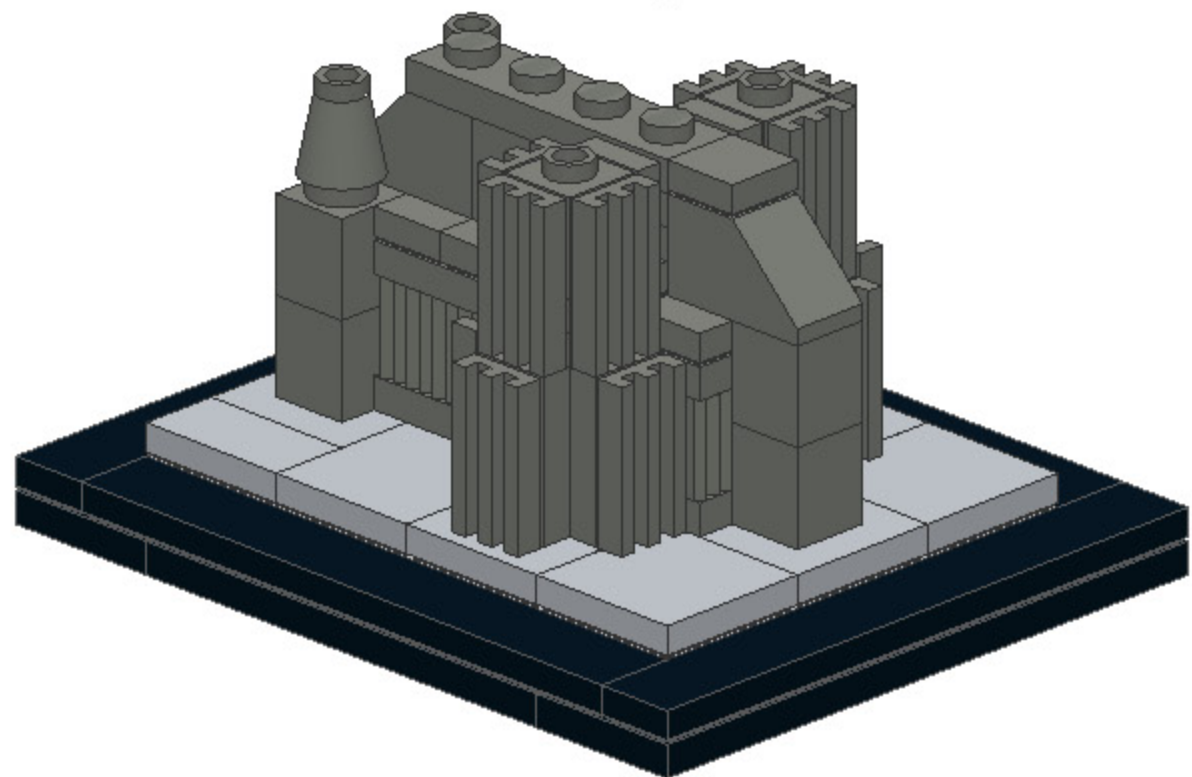

14 
3x



15 
6x



16 
1x

1x

1x

2x

1x 
5x

